

1 General

The GMC-3 is a motor control unit for 1-phase electric motors with two running directions and a limit switch system. The GMC-3 is suitable for 3 motors. The motor can be operated manually as well as automatically. The nominal motor current can be adjusted from 0.4 A to 6.5 A. The GMC-3 is provided with a lockable mains switch, manual control and current measurement.

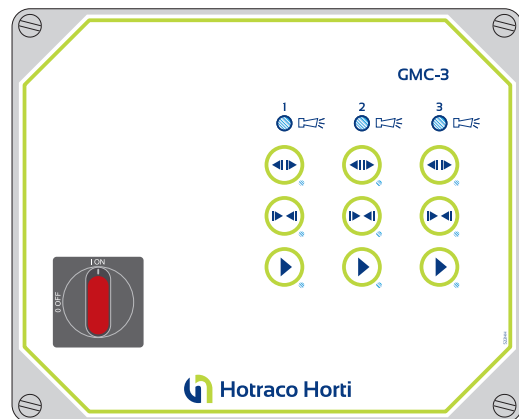

2 Safety

- This device falls under the guarantee- and responsibility regulation, as stated in the general terms and conditions for sale of Hotraco Horti B.V., which is applicable to the agreement with which this device is delivered.
- The GMC may only be used for controlling electric drives with a limit switch system. Use other than described in this manual is not permitted without express consent from Hotraco Horti B.V.
- The GMC is under no circumstances a safety component.
- It is necessary to connect the alarm contacts of the several computers on a central alarm-unit.
- Always leave the GMC switched on. Do not switch off the computer when it is not in use; this is to prevent the GMC against condensation through cooling.
- Do not use running water to clean the GMC. The GMC is water resistant, not waterproof!
- The GMC may only be operated and adjusted by persons who are familiar with the operating instructions provided in this manual.
- The person who operates or adjusts the GMC must be aware of all potential dangers of the systems that the GMC controls.
- A defective GMC is unsafe! In the event of a defect, the systems in which the GMC is used are out of service until the GMC has been repaired.
- The GMC is an electronic device, therefore always take into account that a disturbance or malfunction can occur.



3 Operation

Mains switch

The power supply can be switched on or off by using the mains switch. The mains switch can be locked with a pad lock when it is in the off position.

Operating keys



















Operating keys per motor:















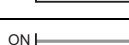















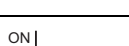

	Manual opening	Press shortly to start the motion. Press shortly to stop the motion. (Only in the manual mode.)
	Manual closing	Press shortly to start the motion. Press shortly to stop the motion. (Only in the manual mode.)
	Operation mode	Operation mode: press the key to change the operating mode. ON = Automatic mode. OFF = Manual mode.

Remark The GMC is provided with an automatic reverse delay.

Signal LED

Each operating key is provided with a signal LED. The LED informs you about the operating state of the electric drive.

			Description
ON OFF 	ON OFF 	ON OFF 	Manual control, motor doesn't run.
ON OFF 	ON OFF 	ON OFF 	Manual opening.
ON OFF 	ON OFF 	ON OFF 	Manual closing.
ON OFF 	ON OFF 	ON OFF 	Manual opening, limit switch reached.
ON OFF 	ON OFF 	ON OFF 	Manual closing, limit switch reached.

			Description
ON  OFF 	ON  OFF 	ON  OFF 	Automatic control, motor doesn't run.
ON  OFF 	ON  OFF 	ON  OFF 	Automatic opening by the main controller.
ON  OFF 	ON  OFF 	ON  OFF 	Automatic closing by the main controller.
ON  OFF 	ON  OFF 	ON  OFF 	Automatic opening by the main controller, limit switch reached.
ON  OFF 	ON  OFF 	ON  OFF 	Automatic closing by the main controller, limit switch reached.

4 Maintenance







During maintenance of the installation, the functionality of the GMC needs to be checked.

5 Problem solving

IMPORTANT! The work procedures that are described in this chapter must always be carried out in a safe way. Prevent unexpected starts of the drive, during checking or repairing the drive.

Malfunction LED

The malfunction LED is placed above the operating keys.

Signal	Meaning	Solution
ON  OFF  	Emergency limit switch activated.	Emergency limit switch activated because the drive has run through a limit switch. <ol style="list-style-type: none"> 1. Check the drive. 2. Correct the situation. Release the drive from the emergency limit switch.
ON  OFF  	Thermal protection activated.	The drive is overloaded or there is a power supply problem. <ol style="list-style-type: none"> 1. Check the drive. The drive might be blocked or there is too much resistance. 2. Check the thermal protection setting; maybe the setting is too narrow, see Chapter 6.3. 3. Check the power supply; maybe one of the phases has dropped out. The thermal protection trips when one of the phases drops out. 4. Check the power supply. The thermal protection trips even when no current is measured while the motor is controlled. 5. Wait 5 minutes before switching on the motor again.

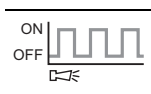
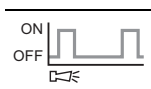
	EEPROM fault.	<p>The GMC has lost the previous state.</p> <ol style="list-style-type: none"> 1. This message always appears when the GMC starts up for the first time (memory empty). 2. The EEPROM cannot be read; the GMC goes into the <i>manual off</i> mode after solving the failure.
	Hardware failure.	Contact your supplier.

Remark

- To reset the GMC, press one of the keys.
- The GMC automatically comes back in the last saved operating mode. In case the malfunction has occurred during manual operation, the GMC automatically comes back in the mode *manual off*.
- You can analyze the state off the GMC by means of the MCSD service display, see also Chapter 6.3.
- When an alarm occurred because there is no current, the motor remains activated. When the current starts to run, the alarm is automatically reset.

6 Installation and set up

6.1 Technical data

Electrical

Power supply	:	230 Vac, P+N+E, Freq. 50/60 Hz \pm 10%
Pre-fuse	:	max. 16 A
Current	:	max. 19.6 A

Motor connection

Motor (3x)	:	230 Vac, Freq. 50/60 Hz, 2 running directions
Contact load per motor	:	max. 6.5 A
Thermal protection adjustment range	:	0.4 ... 6.5 A

Inputs

OPEN/CLOSE/COMM	:	24 Vac/dc, 8 mA
Limit switches <i>open/close</i>	:	24 Vdc, 20 mA
Limit switches <i>emergency</i>	:	24 Vdc, 93 mA, when the relay is activated
	:	24 Vdc, 5 mA, when the relay is inactive

Outputs

Contact load alarm relay	:	24 Vac/dc, 0.5 A
Power supply	:	24 Vdc, max. 180 mA

CE-directions

EMC	:	2004 / 108 / EG
Low voltage	:	2006 / 95 / EG

Mechanical

Ambient temperature	:	0...50 °C
Dimensions (H x W x D)	:	220 x 270 x 115 mm
Housing	:	IP 54, PVC

6.2 Mounting and wiring



This product should be installed by an approved installer with certification according to the relevant prevailing standards (BS-ANSI-ISO, for example). The installer must possess the knowledge of and experience with electronic control equipment required to install the GMC.

- Mount the GMC on a wall in a dry and vibration-free location.
- Connect the GMC in accordance with connection diagrams.
- Adjust the nominal current for each motor.
- Once you have made all the connections seal the glands leading to the box thoroughly with mastic and close the cover of the box ready for use.

Remark The cover can be removed from the GMC only once the main power switch has been set to OFF.

6.3 Service display MCSD

By using the MCSD service display you are able to view the state of the GMC and are you able to adjust the thermal protection more precisely.

1. Put the plug of the service display in the connector on the GMC board (see Chapter 6.5). The service display starts up.
2. Select the motor by means of the   keys.
3. Select the required information with the  keys. Each motor has 3 information screens.

Limit switches

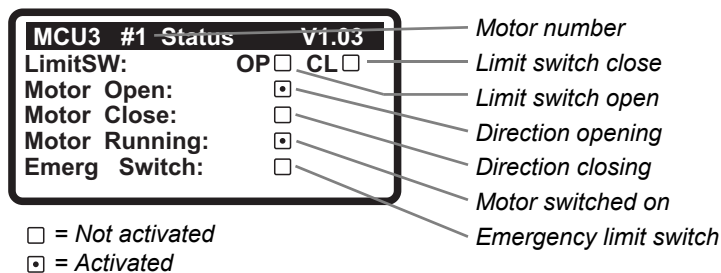

Thermal protection

MCU3 #1 Current		V1.03
Nom: 1.32 ^A	L2: 1.02 ^A	0.00
0.00	L3: 0.00 ^A	
Overload	<input type="checkbox"/>	259.0 ^s
Unbalanced	<input checked="" type="checkbox"/>	1.0 ^s
LowCurrent	<input type="checkbox"/>	

= Not activated
 = Activated

Adjusted nominal current
 Measured current phase 2
 Measured current phase 3
 Current factor
 Overload + switch off time
 Phases unbalanced

- *Current factor* < 1 = normal functioning
- *Current factor* > 1 = measured current is above the nominal current. The motor will be switched off if this lasts for more than the *switch off time*. The *switch off time* shortens when the current factor rises.
- The motor will be switched off immediately when one of the power phases drops out (*unbalanced*).

Management

MCU3 #1 Mngment		V1.03
RunningHours:	22:23:33	
NrOfSwitching:	563	

Run time motors in hours
 Number of times the motor has been switched on

Remark The management data are tracked continuously but will only be saved to the permanent memory once every 24 hour. If in the meanwhile the power supply is interrupted the management data might be lost, but only the data that not have been saved.

6.4 Options

Emergency-stop-by-pass: These are additional keys for by passing the circuit of the emergency limit switches in case of an emergency stop.

IMPORTANT!

- **Only apply the emergency-stop-by-pass when the situation is save.**
- **If the emergency-stop-by-pass is activated the running direction is not guarded. The installation can be damaged seriously if you activate the wrong running direction.**

6.5 Wiring diagram

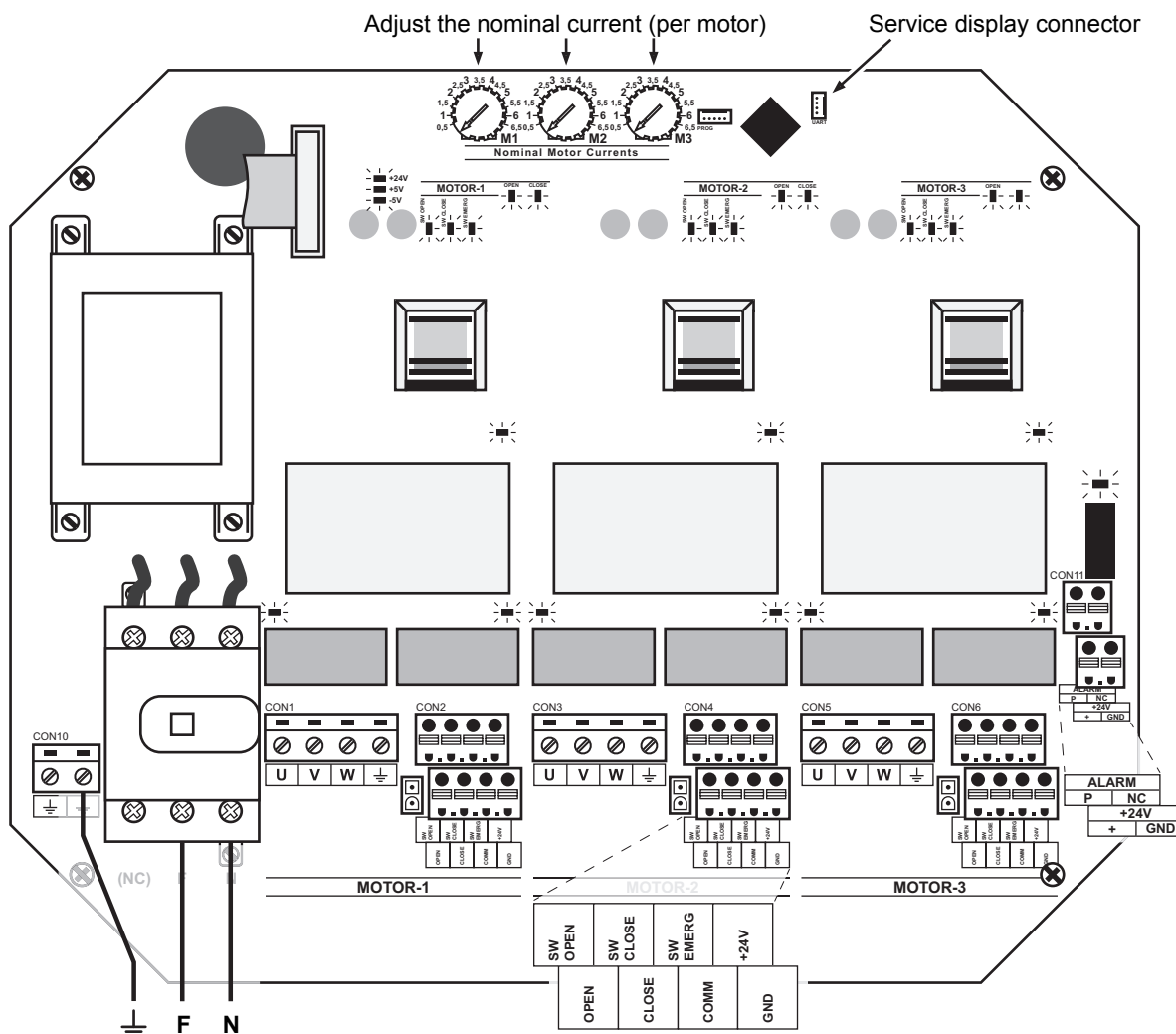

Power 230Vac, P+N+E, 50/60Hz

Connector for emergency-stop-by-pass

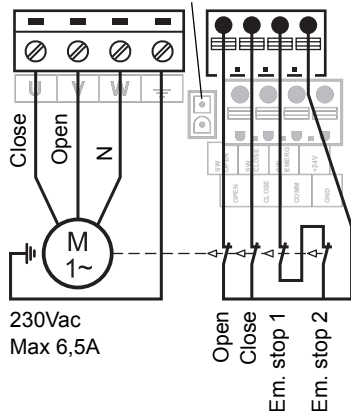

Motor + limit switches (per motor)

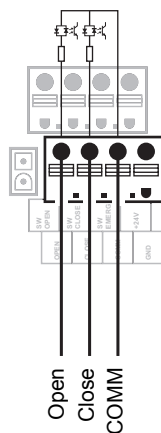

Computer control (per motor)

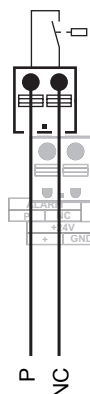

Alarm contact

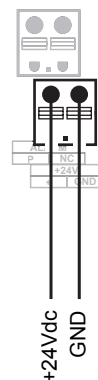

24Vdc